



Product info sheet no. F 5.1

Accessories

Filters and mounting supports

Description

The products on this info sheet are used for adapting sensors to the different places of application. Filters protect the sensor against mechanical damage resulting from particle bombardment at relatively high air speeds and damaging deposits. The filters also keep harmful gases from the sensor. Deposits of oil and grease on the filter lead to corrupted measurements which can be rectified by changing the filter.





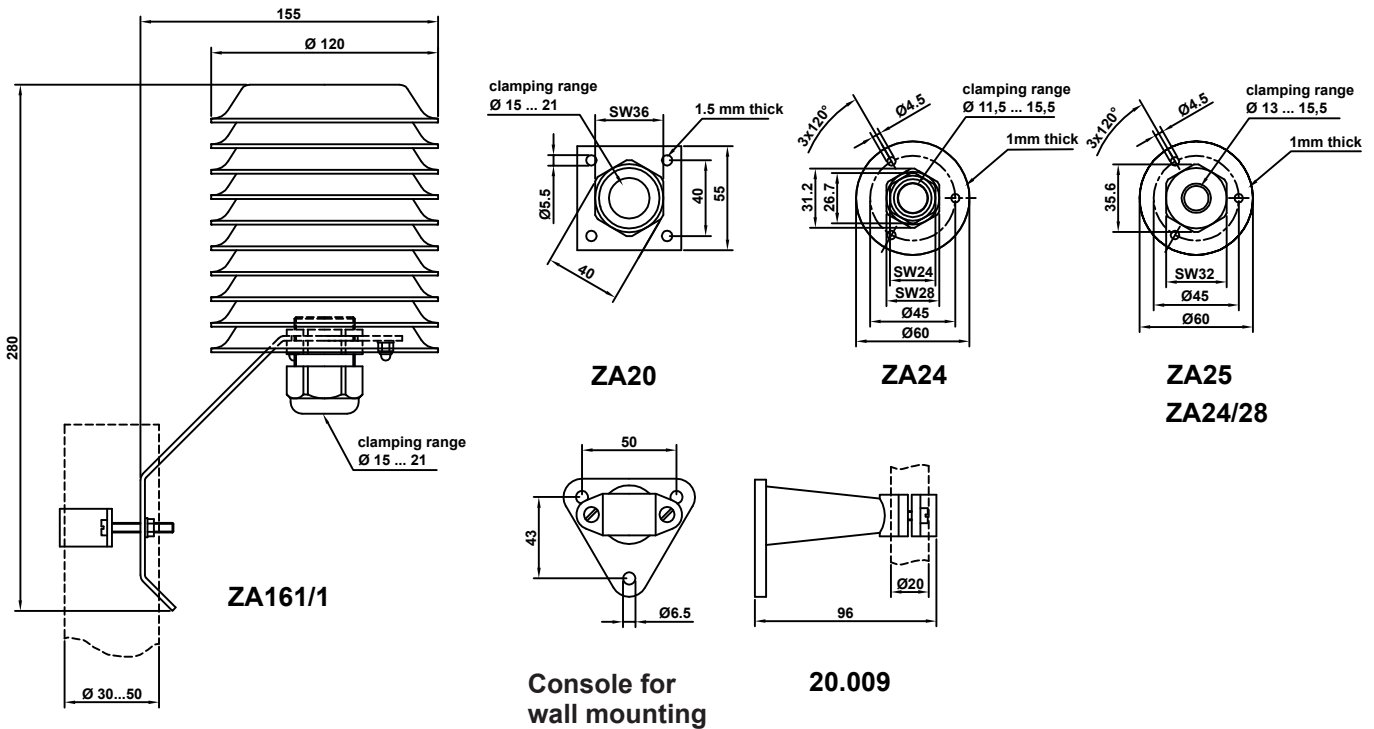

User instructions

Filters, and in particular sintered filters, change the dynamic behaviour of the sensors. Wet filters yield corrupted measurements until they have dried out fully. To avoid corrosion we recommend to treat the threads of filters ZE20...ZE22 slightly with acid-free grease.







Dimensions









Mounting supports

	ZA20	Mounting plate, suitable for mounting sensors Ø 20 mm in ventilation ducts up to 80°C
	ZA24	Mounting plate, suitable for mounting sensors Ø 15 mm in ventilation ducts up to 200°C (stainless steel base plate with brass fitting)
	ZA24/28	The same properties as ZA24, but suitable for sensors Ø 15 mm and Ø 20 mm
	ZA25	Mounting plate, suitable for mounting sensors Ø 15 mm in ventilation ducts up to 100°C, preferably for use in gases containing ammonia. (stainless steel base plate with stainless steel fitting)
	ZA27	Pressure-tight feed-through fitting, thread G 1/2" x 12, brass pressure-tight up to 6 bar, suitable for temperatures up to 180°C
	ZA28	Pressure-tight feed-through fitting, thread G 3/4" with locking ring, stainless steel pressure-tight up to 10 bar, suitable for temperatures up to 150°C
	ZA30	Assembly kit for add-on humidity switch FGO and FGS comprising adhesive strips and heat conductivity paste, for mounting on smooth surfaces.
	ZA40	Assembly kit for sensors with ATEX certificate for connection to zone 0
	ZA161/1	Weather guard for cable versions Ø 20 mm with mounting sleeve 00.502 suitable for sensor tubes Ø 15 mm <i>recommended for protection against rain and sun in case of outdoor applications</i>



Filter for sensor tubes Ø 20 mm

	Type / Product No.	Description	Response time Humidity at v = 1.5 m/s
	ZE16	Protective basket of PBT plastic, side openings, metallized finish. Protection against mechanical impacts, suitable for low air speed and clean, non-aggressive atmosphere. Ø 20 x 25, M 18x1 Operating temperature range: -40...85°C IP20	< 20 s
	ZE17	Same as type ZE16, but with inserted filter gauze made of high-grade steel, mesh size approx. 0.11 mm. Protection against mechanical impacts and coarse dirt. Suitable for low air speed and clean, non-aggressive atmosphere. Ø 20 x 25, M 18x1 Operating temperature range: -40...85°C IP40	< 1 min
	ZE18	Sintered filter made of fine-pored PTFE for use in extreme conditions, average pore size 20 µm. Meets the EMC directive for the I Series; but not for the other sensors. Ø 20 x 25, M 18x1 Operating temperature range: -80...200°C IP65	< 3 min
	ZE20	PBT plastic filter, metallized, with inserted filter gauze (nominal pore size 0.45 µm), v up to approx. 10m/s. Protects against aerosols. Ø 20 x 25, M 18x1 Operating temperature range: -40...85°C IP54	< 1.5 min
	ZE21	Fine-pored sintered filter made of high-grade steel 1.4404, v up to approx. 20m/s. Protects the sensor element against high air speeds and dusty conditions. Ø 20 x 25, M 18x1 Operating temperature range: -50...150°C IP65	< 1.5 min
	ZE22	Same as type ZE21, but coarse-pored (max. pore size 100 µm) and dynamically faster, v up to approx. 20m/s Ø 20 x 25, M 18x1 Operating temperature range: -50...150°C IP65	< 1.5 min

Filter for sensor tubes Ø 15 mm

	Type / Product No.	Description	Response time Humidity at v = 1.5 m/s
	ZE13	Coarse-pored sintered filter made of high-grade steel 1.4404 (max. pore size 100 µm). Protects the sensor element against high air speeds and dusty conditions. v up to approx. 20m/s. Ø 15 x 33, M 14x1 Operating temperature range: -80...200°C IP65	< 1.5 min
	ZE04	Filter made of high-grade steel 1.4301, side openings, front open. Protection against mechanical impacts. Suitable for low air speed and clean atmosphere. Ø 15 x 39, M 14x1 Operating temperature range: -80...200°C IP10	20 s
	ZE15	Filter made of high-grade steel 1.4301 with inserted filter gauze made of high-grade steel, mesh size approx. 0.11 mm. Protection against mechanical impacts and coarse dirt. Suitable for low air speed and clean atmosphere. Ø 15 x 39, M 14x1 Operating temperature range: -80...200°C IP40	< 1 min
	ZE26	Filter made of high-grade steel 1.4301 with inserted filter gauze and membrane (nominal pore size 0.45 µm). Protects against aerosols and dust. v up to approx. 10m/s. Ø 15 x 39, M 14x1 Operating temperature range: -50...150°C (max. 1h 200°C) IP54	< 2 min
	ZE28	High-grade steel filter with mounted ZE18 (filter made of sintered PTFE), average pore size approx. 20 µm, for sensor tubes Ø 15mm. For use in extreme conditions. Ø 20 x 37, M 14x1 Operating temperature range: -50...200°C IP65	< 3 min
	ZE29	Sintered filter made of fine-pored PTFE, average pore size approx. 20 µm. For use in particularly demanding conditions. Meets the EMC directive for the A/B series, but not for the other sensors. Ø 15 x 39, M 14x1 Operating temperature range: -80...200°C IP65	< 3 min

Filter for sensor tubes Ø 12 mm

	Type / Product No.	Description	Response time Humidity at v = 1.5 m/s
	ZE05 / 20.077	Sintered filter made of fine-pored PTFE for use in extreme conditions, average pore size 20 µm. Ø 12 x 35, M 10x0.75 (with seal ring) Operating temperature range: -40...125°C IP65	< 3 min
	ZE07 / 23.064	Protective basket made of PC plastic, signal white, side openings, suitable for low air speed and clean atmosphere. Ø 12 x 33, M 10x0.75 Operating temperature range: -40...85°C IP20	< 20 s
	ZE08 / 20.044	Membrane filter made of PC plastic, signal white. Protects against aerosols and dust, suitable for air speed up to approx. 10m/s. Ø 12 x 33, M 10x0.75 Operating temperature range: -40...85°C IP30	< 1.5 min