

- NDIR CO₂ Dual sensor
- Needless calibration on long-term use
- Output Type
 - RS-485 + 4 ~ 20mA (SH-VT260AS).
 - RS-485 + 0~5V (SH-VT260VS).



- **ROHS, DESIGN PATENT(No. 30-0772530).**
- **PATENT No. 10-1349965**
- **PATENT No. 10-1796918**
- CO₂, Temperature, Humidity Transmitter.
- Applications.
 - ◇ Ventilation Control.
 - ◇ CO₂ Supply system.
 - ◇ HVAC(Heat Ventilation Air Conditioning system)
 - ◇ Mushroom Farming Greenhouse.
 - ◇ Livestock circulation system.
 - ◇ Farm House circulation system.
 - ◇ LT(Low Temperature) storage.

SOHA TECH CO.,Ltd
Suite 104, Hagye technotown A, 250-3
Tel: +82 2 978 0461,2,5 FAX: +82 2 978 0463

<http://www.soha-tech.com>

♣ This product can be changed for quality improvement without notification

■ SPECIFICATIONS.
1. CO₂(Carbon dioxide)sensor .

List	Content	Remark
Type	NDIR Type	
Range	0~3000ppm, 0~5000ppm, 0~10000ppm	(4~20mA, 0~5V) Option
Accuracy	Full Scale 의 ±2%, ±3% of measurement,	@ 0 ~ 50℃
Signaling period	Every 2.0 Seconds	
Warm-up Time	@25℃ < 90Sec	
Working condition	-10 ~ 50℃	
	0 ~ 99.5%RH	Non-dew point

2. Temperature sensor (Thermometer).

List	Content	Remark
Range	-25.0 ~ 85.0℃	(RS-485)
	-10.0 ~ 50.0℃	(4~20mA, 0~5V) Option
Accuracy	±0.3 ℃	Max(picture)
Response	5 ~ 30 Sec	

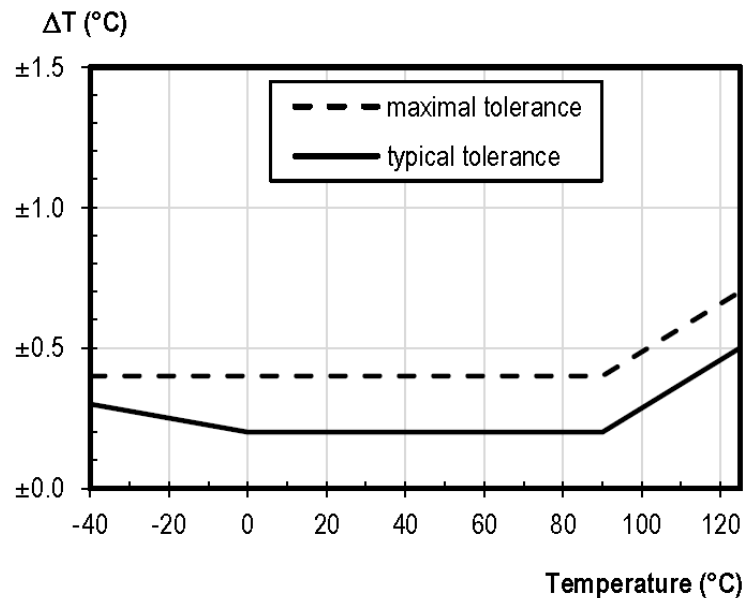

3. Humidity(Hygrometer) sensor .

List	Content	Remark
Range	0 ~ 99.9 %RH	(4~20mA, 0~5V) Option
Accuracy	± 2 %RH	Max(picture)
Response	8 Sec	

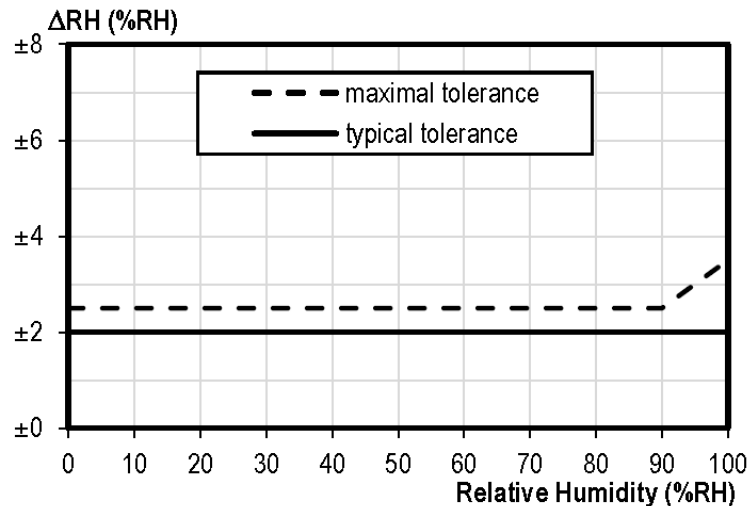

4. Power: DC12V ~ 24V more 200mA .

5. Consumption: Normal 40mA, Peak 135mA.

6. Model :

- SH-VT260ASM2

; RS-485 + DC 4 ~ 20mA / Temp/Humidity sensor Full covered

- SH-VT260VSM2

; RS-485 + DC 0 ~ 5V / Temp/Humidity sensor Full covered

■ Feature.

1. Data transmitter are able to communicate with SH-VT200C, PLC or/and MICOM are able to access as well.
2. It was designed to able to measure stable value on the water contact circumstance among amongst humidity which create a dew.
3. Low Cost, High Quality.
4. RS-485 Modbus available.
5. Analog OUTPUT(4~20mA,0~5V(Option)) and Digital OUTPUT(RS-485) available simultaneously.
6. Temp/Humidity sensors are full covered for waterproof, available on 100% humidity condition

■ PROTOCOL(MODBUS).
Modbus Address Map.

Address		PROCESS (2 byte)	Reading /Writing
Hex	Dec		
0x64	100	CO2 Value	Reading
0x66	102	Temperature Value	Reading
0x68	104	Humidity Value	Reading
0x6A	106	Temp/Humidity sensor's error 0x00 0x30 : Normality 0x00 0x31 : Abnormality	Reading
0x6C	108	Device ID (refer to additional explanation)	Reading /Writing

※ Temp/Humidity measurement value is to [Value multiple 10], the designer can apply actual value as formulation which divide by 10

Ex) (Addr.0x66(102)) 253(0x00FD)→ Real Value 25.3℃,
(Addr.0x66(102))-123(0xFF85)→ Read Value -12.3℃,
(Addr.0x68(104)) 536(0x0218) → Real Value 53.6%.

※ When Device ID process the writing order, Hex switch value must be 01 before start.

1. Power OFF.
2. Hex S/W : 1.
; ID is 01 as standard setup
3. Power ON.
4. Device ID set
5. Power OFF.
6. Hex S/W : F.
7. Power ON.
8. Normal communication as set Device ID .

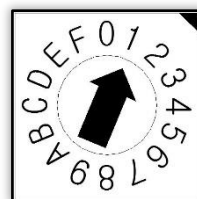

[Hex S/W :setup 01]

■ Modbus explanation.
(ID Setting)

Function code 03 : Read Holding Registers

1 This is function code which are able to read the word data status. The next chart is the exemplary of reading address 100, 102 SH-VT250 from VT250 ID 01.

Query:

Field	DATA	Count
VT260 ID	0x01	1
Function code	0x03	1
Beginning Address HI	0x00	1
Beginning Address L0	0x64	1
Length HI	0x00	1
Length L0	0x02	1
Check error	CRC	2

The response is as below. 1 word are 2 bytes so it is responded 4 bits.

Response:

Field	DATA	Count
VT260 ID	0x01	1
Function code	0x03	1
Bite count	0x04	1
Data 1 HI	0x01	1
Data 1 L0	0x47	1
Data 2 HI	0x01	1
Data 2 L0	0x05	1
Check error	CRC	2

Query :

0x01 0x03 0x00 0x64 0x00 0x02 0x85 0xD4

Response :

0x01 0x03 0x04 0x01 0x47 0x01 0x05 0x8A 0x49

C02 Value : 0x0147 => 327 PPM
 Temperature Value : 0x0105 => 26.1°C

Function code 06 : Preset Single Registers

This is function code which are able to change 1 word value.
 The next chart is the exemplary of making change VT250 ID 1 to ID 10(0x0A).

Query:

Field	DATA	Count
VT260 ID	0x01	1
Function code	0x06	1
Beginning Address HI	0x00	1
Beginning Address LO	0x6C	1
Length HI	0x00	1
Length LO	0x0A	1
Check error	CRC	2

The response is as below

Response:

Field	DATA	Count
VT260 ID	0x01	1
Function code	0x06	1
Beginning Address HI	0x00	1
Beginning Address LO	0x6C	1
Length HI	0x00	1
Length LO	0x0A	1
Check error	CRC	2

Query :





0x01 0x06 0x00 0x6C 0x00 0x0A 0xC9 0xD0

Response :

0x01 0x06 0x00 0x6C 0x00 0x0A 0xC9 0xD0

■ Hex Switch ID
Setting
(SH-VT260)

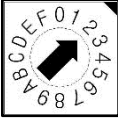
1. Hex Switch.

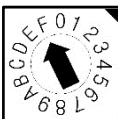
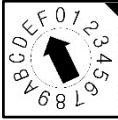
	<p>0 => Data transmission every 2sec(unconditional).</p>
	<p>1 => ID set as 1 data transmission will be processed only by the request.</p>
	<p>2 => ID set as 2, data transmission will be processed only by the request.</p>
	<p>3 => ID set as 3, data transmission will be processed only by the request</p>
	<p>· · ·</p>
	<p>14 => ID set as 14, data transmission will be processed only by the REQ</p>
	<p>15 => Available to modify by UART communication, when choose setup more 1 ID.</p>

2. If HEX switch value were 0, Serial communication aren't able to change the configuration. ID more 1 setup and are able to change the configuration.

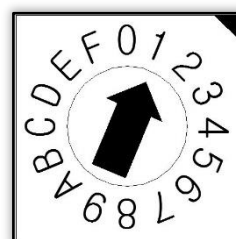

[S/W1 : setup 01]

3. If the switch were value 15(F), it is able to operate and monitoring the configuration of communication and data process with PC management program.

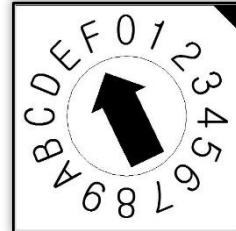

[S/W1 : setup F(15)]

4. Baud Rate: 9600bps.

■ M o d e configuration of analog output, check the location of ID and current, voltage.

- Current location



- Voltage location



Choose the Current or Voltage with Jumper PIN

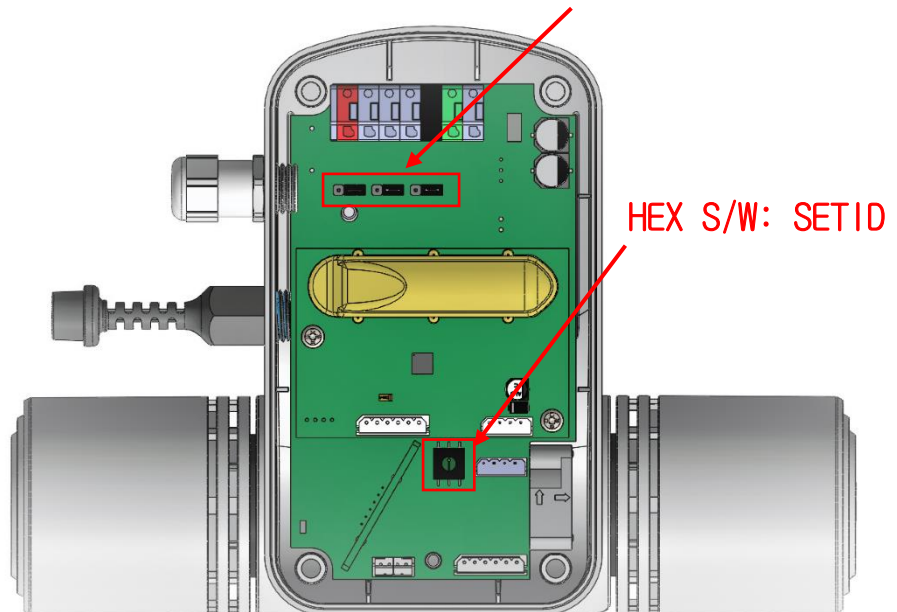

BEWARE, this is for **hardware process**, this process also need **software process**. It means that It is not able to change the way of loop in the field urgently. You should be consulted with manufacturer before change.

■ CAUTION

This detective device isn't allowed to contact with VOCs.

We shouldn't advice to use in sealed space.

(VOCs emit from epoxy, adhesive etc when be curing or drying)

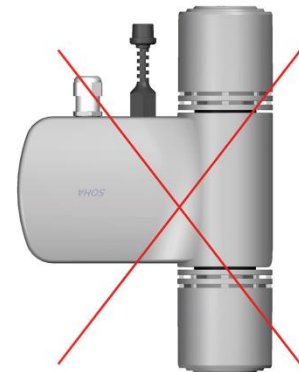
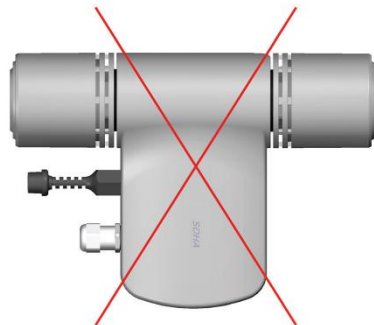
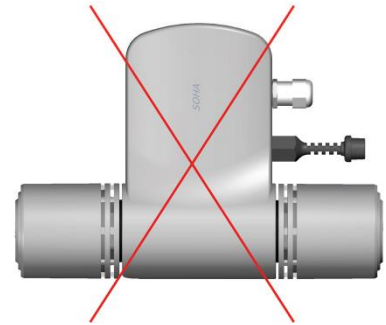

※SH-VT260 caution for setup.

1. SH-VT260 must be placed as picture above.
2. Do not power off when you use the product.
3. Power off and wrong placement has a possibility to infiltrate humidity into inside, could cause a malfunction.
4. If necessary to off the power, be advised store in no severe humidity and dew-point.
5. Be advised to full cover and move to other place where are able to avoid VOCs, when regular hydrogen operation necessarily.
(Sensors could be malfunction)

■ Dimension

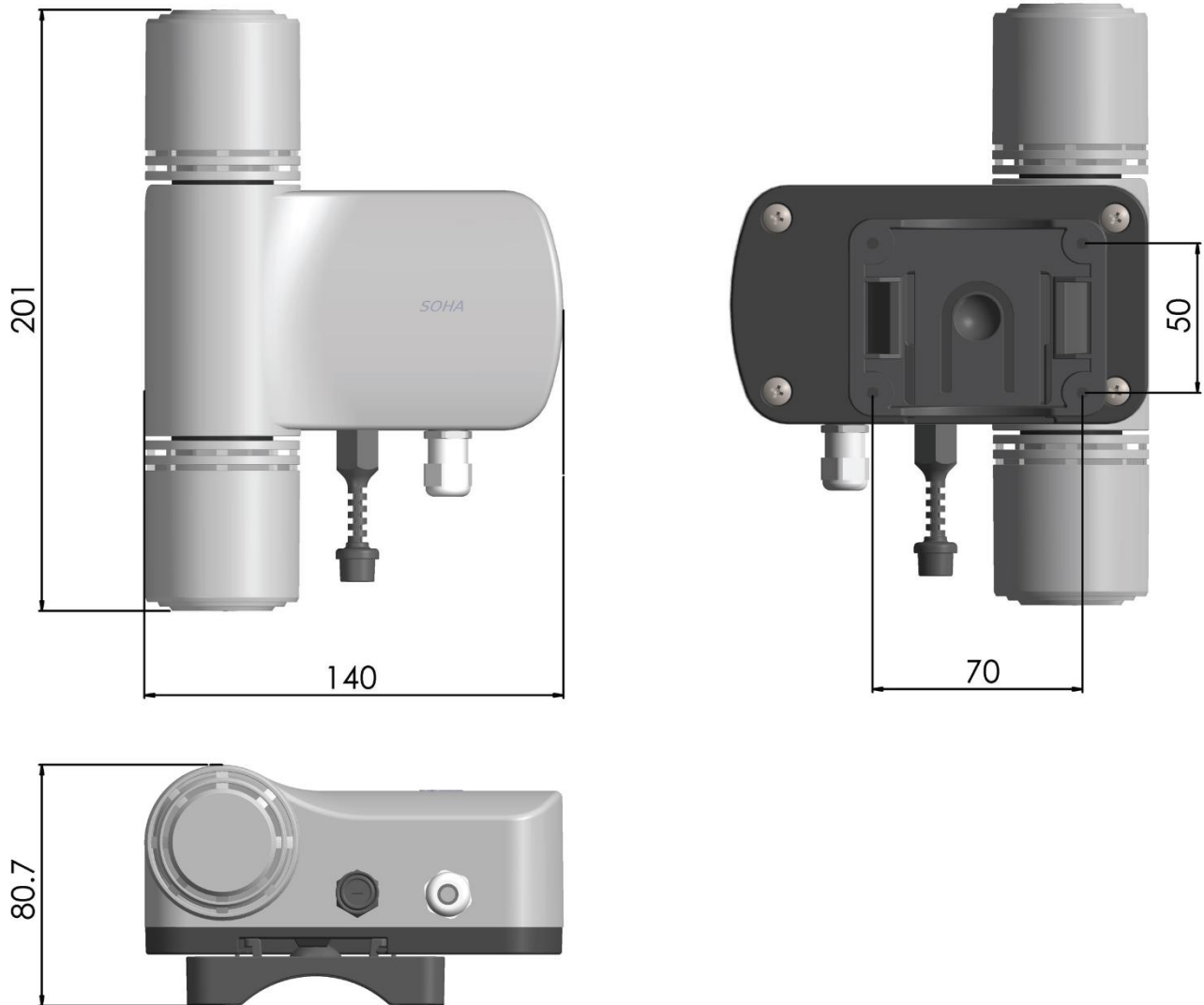

■ Wiring diagram

